

United States

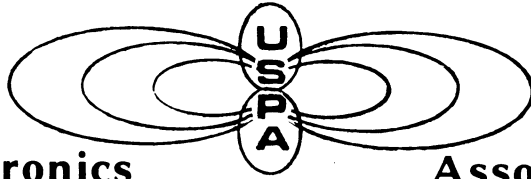

Psychotronics

Association

Non-profit organization

Summer 1980

NEWSLETTER

Volume 2 Number 2

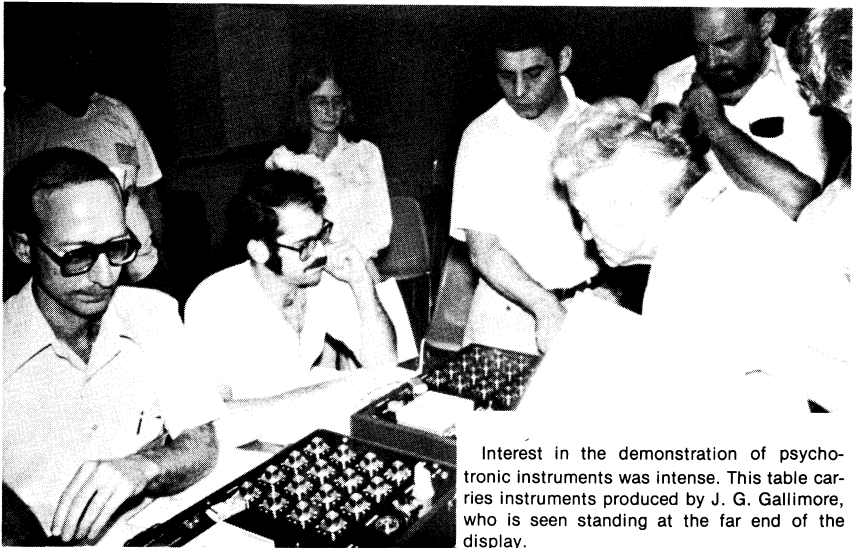

Interest in the demonstration of psychotronic instruments was intense. This table carries instruments produced by J. G. Gallimore, who is seen standing at the far end of the display.

1980 Dayton Conference

In the most heavily attended conference to date, the U.S. Psychotronics Association met at Bergamo Hall, Dayton, Ohio, July 25 to 27 to hear 2½ days of reports by active researchers.

Presided over by USPA President David Rhoads and Conference Chairman Peter Kelly the well organized meeting elicited positive comment from participants.

A meeting of the executive committee preceding the conference considered a number of association matters and voted changes in communications and public relations functions. The publications committee was expanded and the USPA newsletter was scheduled for quarterly publication. A proceedings and tape recordings of conference papers are in preparation.

continued on page 4

U.S. Psychotronics Association, Inc.

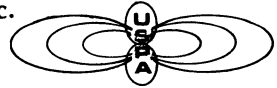

BOARD OF DIRECTORS:

T. Galen Hieronymous
J. G. Gallimore
Charles Whitehouse
Rev. Henry J. Nagorka
Robert C. Beck
Peter Kelly
Thomas Bearden
Joan Orion
Paul Sauvin
David Rhoads

OFFICERS:

J. G. Gallimore, Pres.
Peter Kelly, 1st V.P.
David Rhoads, Exec. Secy.
Robert Beutlich, Secy.-Treas.
3459 Montrose, Chicago, IL 60618
(312) 478-7715

CONTENTS

NEWS

1980 USPA Conference	1
Psychotronics in the News	3
1980 Conference Photos	12

FEATURES

Selection of Abstracts of Papers Presented at Dayton	5
The Magnetic Pacer — A Countermeasure for ELF Magnetic Radiation — William Bise	15

DEPARTMENTS

Book Reviews	19
USPA Aims and Membership Information	18
Tape Recordings Available	
1978 Conference	21
1979 Conference	22
1980 Conference	23

EDITORIAL STAFF

Rev. Henry J. Nagorka
Kathleen Joyce Baumgartner

Editor/Coordinator
Editorial Assistant

Advisors

Thomas E. Bearden — Science/Technology
Peter Kelly — Psychotronic Hardware
Paul Sauvin — Bioenergetics/Plant Sensitivity

Psychotronics IN THE NEWS

ELF Detector May Go Into Production

The Pacific Northwest Center for the study of non-ionizing radiation is accepting downpayments of 10% on orders for an Extremely Low Frequency (magnetic radiation) detector. The suggested retail price is set for \$385.00 and will require readout device.

The Pacific Northwest Center for the Study of Non-Ionizing Radiation, Box 22053, Milwaukee, Oregon 97222.

IAPR Asks For Support

The August newsletter of the International Association for Psychotronic Research has appealed to its correspondents for financial support through joining the organization. According to editors Manuela Molitor and Tom Loewen, most of the 300 newsletter recipients are not members.

Membership information is available from 1 A.P.R., 2 rue Jean Engling, Luxembourg.

New Soviet Bibliography on Parapsychology

The Spring 1980 issue of the USPA newsletter reported the emigration to Israel of Soviet parapsychologist Larissa V. Vilenskaya.

The newsletter has learned that Vilenskaya has finished the compilation of a new bibliography on Soviet parapsychology.

Iridotronic Conference

The International Association for Psychotronic Research (and Division for Iridotronic Research) announced the First International Conference on Iridotronic Research for Sept 29 —

October 2, 1980, at Fibichova Street 19, 736 01 Havirov, Czechoslovakia.

Generally referred to as iridology in the United States, iridotronics is a diagnostic modality based upon the examination of the iris.

Sponsors are listed as Dr. Zdenek Rejdak, President of IAPR; Prof. M.D. Romashov, F.N., President of the preparatory committee, and Ervin Wojnar, leader of the division of iridotronic research.

FDA Requests Cooperation of USPA President

The Indianapolis, Indiana, office of the Federal Drug Administration, an arm of HEW which has in the past classed radionics as fraudulent, has approached J. G. Gallimore, President of USPA with a request for collaboration. The unofficial support of radionic treatment however, represents a psychological approach to a difficult case rather than the reversal of established FDA policy.

Pervier Design Wins Logo Contest

The USPA logo contest winner is Curt Pervier of Midland, Texas. The new logo now decorates the masthead of the newsletter as well as other USPA literature and documents.

The logo is a stylized representation of the hyperfield flux in a magnetic field surrounding the south pole of a magnet.

Pervier has been awarded lifetime honorary membership in USPA.

Fifth International Conference on Psychotronic Research

The fifth IAPR Conference is scheduled for the Summer of 1981 in Bucharest, Rumania. It will be held under the aegis of the National Council for Science and Technology of Rumania.→

The Charles Whitehouse Case

Charles F. Whitehouse, D.C., member of the Board of USPA under attack by the Virginia State Board of Medicine (see page 7) on September 11th has been deprived of his license to practice. Hearing officer Charles F. Poston, a Norfolk lawyer recommended that Whitehouse's license be revoked for "gross malpractice and fraud."

While deciding whether to appeal to the Norfolk Circuit Court Whitehouse plans to continue the work of the Etheronic Research Foundation under the umbrella of a church.

USPA Directors approved support for Whitehouse's defense effort in the amount of \$500.00 during the 1980 Conference.

The Whitehouse case also gained the interest of the National Health Federation. Dr. Clinton Miller, President of the Federation, as a keynote speaker at the Dayton conference delivered a rousing defense of Whitehouse and new modalities of healing.

The case has attracted broad attention in alternative healing circles and in the Virginia press. A sampling of the three months from July to September discloses the following coverage: *Metro* the Magazine of South-eastern Virginia, July, Vol. 10 No. 7, 46 inches; *Virginian-Pilot*, August 16, 34 inches; *Virginian-Pilot*, August 21, 38 inches; *The Beacon*, August 21/22, 15 inches; *The National Enquirer* on September 2 carried a ten inch story on the Navy's use of Whitehouse and purchase of his equipment for tracking submarines; *The Beacon*, Sept 4/5, 18 inches; *The Ledger-Star*, Sept 11, 5 inches; *The Virginian-Pilot*, Sept. 12, 14 inches.

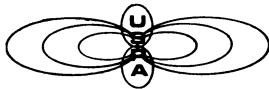

The program of presentations included the following:

Energy Training and Consciousness Awareness — Joan Orion

Quarks, Occult Chemistry, and the String Model — Bob Beutlich

Instrument Research and Design — Kathleen Joyce

Alteration of Brain Frequencies for Space Communication — Ann Johnson

Evidence Presented by Virginia Board of Medicine vs. Whitehouse, Pro and Con — Dr. Charles Whitehouse

Bio-Types — William Wolensky

A Magnetic Pacer — Al Bielek and Bill Bise

Mathematics of Cone Design — Joseph McGuire

The Charles Whitehouse Case — Clinton Miller

Update on Advanced Sciences R & D Corporation — Peter Kelly

Mind and Matter Interaction — Tom Bearden

Para-Physics Exploration — J. G. Gallimore

Integration of Psi in Society — Ira Dember

The Sea of Energy — John E. Moray

Alteration of Brain Frequencies for Space Communication — Ann Johnson

Vacancies on the Board of Directors were filled by the voting membership, resulting in the following composition:

- T. Galen Hieronymus
- J. G. Gallimore
- Dr. Charles Whitehouse
- Rev. Henry J. Nagorka
- Robert C. Beck
- Peter Kelly
- Lt. Col. Thomas E. Bearden U.S. Army (Ret.)
- Joan Orion
- Paul Sauvin
- David Rhoads

continued on page 10

A Selection of Abstracts of Papers Presented At Dayton

MIND AND MATTER INTERACTION

T. E. Bearden

Almost all human concepts, ideas, and logic have been based upon — and fitted to — the photon interaction, which differentiates spacetime (4-space), leaving a spatial (and partial) reality which we detect and observe. Classical (3-law) Aristotlean logic is simply the synthesis of detection/perception after the photon interaction is invoked. Using electrons, Young's two-slit experiment conclusively proves reality changes merely by whether or not the photon interaction is applied to the electron.

Since mind occupies time but is coupled to space only by the factor $1/c^3$, normally mind is spatially *virtual* and thus totally lost in any simple quantum detection process.

Since all objects have temperature and continually exchange photons with their surroundings and within their own makeup, the photon interaction is universal. Human concepts and logic, fitted to this interaction, thus contain a single fundamental shortcoming or "delusion" and most of reality becomes illogical at base.

The author demonstrates a fourth law of logic which, when added to Aristotle's three laws, enables a closed logical system. Using the fourth law of logic, a mind can be modeled as a physical universe, and a physical object can be modeled as superposed "mind cards," each containing that form, from all existing minds. Thus matter is totally mindstuff, while mindstuff is totally physical, and the di-

chotomy between mind and matter is removed. An infinite-dimensional universe results where the "laboratory frame" 3-space is common to all physical mindworlds. Each mindworld is a separate physical universe three or more orthogonal turns away from the laboratory frame in hyperspace.

A thought experiment is used to show a mass can travel at the speed of light, becoming a photon in the process. Velocity is simply a measure of the rotation of an object into hyperspace away from its line of motion in laboratory 3-space, as shown by the direct examination of the Lorentz transform equations. The speed c of electromagnetic energy in vacuum simply represents the rotation of an object (such as an electron) one such orthogonal turn away, so that its projection into the laboratory frame has lost one dimension. An electron so turned has been changed to a two-dimensional transverse front or plane moving at the speed of light — in short, a photon.

The identity between higher dimensional spaces and nested sublevels of virtual state is shown for the first time. Kindling, a method of amplifying virtual state into observable state based on the Prigogine effect, is advanced as a new concept.

Consciousness is rigorously defined as a preferred coherence and tuning loop kindling channel between a physical mass tuner and the intersected virtual state projections from one mind world, and vice versa. This allows

rigorous definition and modeling of a living biosystem and definitions of both "life" and "death." Several specific unexplained phenomena types are presented which can be explained by this new approach to mind and matter and their interaction.

The operation of the neurophone (which puts thoughts into the mind), the Priore device (which cures cancer and leukemia), and the Moray amplifier (which taps zero-point energy of

vacuum) are explained as are the mind control and death induction potentials of the Soviet "woodpecker" signals.

The nature of the collective human unconscious is presented, and how minds and being can be integrated into yet higher-dimensional living entities is shown. The linkage of the entire human species into a multidimensional, unlimited being beyond ordinary space and time is postulated as the final step in human evolution.

"QUARKS, OCCULT CHEMISTRY AND THE STRING MODEL"

Robert Beutlich

Just before the turn of the century, two Theosophical Society members, Leadbeater & Besant clairvoyantly viewed while in the state of 'Samadhi' the simplest of known physical elements, hydrogen, consisting of a single proton in the nucleus and one electron orbiting.

They 'saw' an egg shaped, translucent, rotating, wobbling spheroid. Within the spheroid were little bright lights, a total of six, in two groups of three. Each group of three lights always remained in a spatial relationship with each other in the shape of a triangle. The eggshaped container pushed back space so it was more of a partial vacuum inside the spheroid.

Upon further magnifying the little bright lights, they were seen to be spheres which again contained three more 'little lights.' As these were magnified they appeared as a heart shaped spheroid with ten bands of energy making $2\frac{1}{2}$ turns on the outside surface and returning up from the bottom sharp point, through the center in $2\frac{1}{2}$ turns to the top depression of the heart shaped ovoid.

Two scientists, H. Phillips of England & R. Beutlich, USA, in 1978 wrote articles in the journals of Theosophy/

Science published in England and India respectively. They saw the similarity of the modern quantum physics model of quarks which make up all the fundamental heavy particles in the atomic nucleus and the shapes which Leadbeater & Besant described and published in the book "Occult Chemistry" published by the Theosophical Society.

Mr. Phillips is a physicist and has further proposed a coupling between the light and heavy particles in Physics Review, which accounts for all their properties (not now being done by current classical physics). Also he noted that the energy streams that were clairvoyantly observed holding these little lights together was identical to the theory used for superconductors. He then postulated a system to account for the existing etheric and magnetic charges of the configurations of the various types of quarks that make up the heavy nuclear material.

This is a most exciting confirmation of a psychic ability being used for scientific observation and these findings will in time revolutionize the quantum theories. Hopefully, also, awaken the world of science to the reality of what psychics "see."

**THE STATE OF VIRGINIA VS.
CHARLES F. WHITEHOUSE, D.C.**

Charles F. Whitehouse, D.C.

As a result of pre-hearing investigations conducted by the Attorney General's office, at the request of the Virginia State Board of Medicine, an injunction has been issued requiring Dr. Charles F. Whitehouse, D.C. on Dec. 12, 1979, to cease and desist from all activities regarding research using color therapy, radionics, the transference of mind energies and any parapsychological methods.

Charges of fraud and unconscionable conduct and practicing outside the scope of chiropractic are the main issues.

In addition to pre-hearing activities, an account is given of the hearings from Feb. 27, 1980 to the 24th of July 1980 including a discussion of briefs by the attorney general for the State Board of Medicine and a brief by respondent's attorney.

**CONSCIOUS AWARENESS AND
ENERGY TRAINING**

J.T. Orion

A. Nine years intensely involved in assisting people to greater good health in the most highly adaptive instrument: human being.

1. Act of observing alters reality (*Zukav, The Dancing Wu Li Masters*)
2. New physics: corrolate experience rather than absolute truth. (*Ibid*)

B. Conclusive evidence: "A Study of Structural Integration from Neuro-Muscular, Energy-field and Emotional Approaches" (Hunt, Dept. of Kinesiology, UCLA, 1977.)

1. Includes a model of body-mind changes at the sub-atomic level relating the changes in coherence in structural integration to the Holographic Model.
2. Reactions on oscilloscope.
 - a. Blue, Red, Yellow.
 - b. Higher frequencies, mingled, finer colors.
3. Rolfing: chakras located, monitored, and effects of specific hours (of ten).
4. Nothing to indicate that the eye

and the brain processing centers interpret colors only in the high Kiloherzt frequencies.

5. Similar changes, retaining individual patterns: personalities, occupations.
6. Various sections of the body produced different memories and emotions supporting Wilhelm Reich's theory that memory of experiences is encoded in the body tissue.
7. Relationship between emotional states and these colors is a fact, not Subjective Judgement.

C. Patterns in Brain (*Scientific American*, Oct. '78.)

D Components of imagery exist in both cerebral hemispheres (*Paul Bakan, Simon Frazier Univ., Burnaby, B.C., Canada.*)

1. Muscle relaxation usually left brain,
2. Right brain as a primary course of imagery may be oversimplified,
3. Allows cooperation for free association and recall.

E. Multiple electric impulses in hemispheres: Vowels reverse side for

Western writers and Orientals trained in pictograms.

F. Left brain: verbal and linear; Right brain: non-verbal and spatial: applicable to about 20% of the population.

G. David Bresler, director, UCLA Pain Clinic Unit

1. Limitation of verbal language . . . to affect overt behavior.
2. Response to imagery — a communication with the autonomic system.

H. Klein and Armitage, Dal-Housie Univ. (Halifax, N.S. Canada)

1. 90 to 110 minute cycle, rhythmic change 180 degrees out of phase: verbal vs. spatial.
2. May contaminate measures of performances on tasks that are processed asymmetrically by the two hemispheres.

I. Evolutionary memory not lost, repressed, can be reactivated to regenerate bone, nerve, muscle tissue (*Conrad, Continuum, L.A., Calif.*)

J. Training to promote conscious awareness:

1. Experience, then describe newly reprogrammed awareness.

2. Describe the odor of skunk . . . to someone who has never smelled it.

3. Perception at different levels of consciousness.

K. Seven major vortices emanating from human body:

1. Color, place, most prevalent characteristic of those dominant in human beings.

2. Immediate ricochet from specific area and color to another, consistently.

3. Pink — its effects on and in the human body.

L. The more complex a system, the greater its potential for self transcendence.

1. Parts cooperate to reorganize it.

M. A Subjective experience of insight is a felt shift:

1. EEG shifts.

2. Brain — Alpha waves.

3. Holistic model of reality (*K. Pribram, D. Bohn, 1977*)

4. Functional Integration, M. Feldenkrais

a. Increase sensitivity to posture and internal body states.

N. Respect for and cooperation with pioneers in psychotronics research.

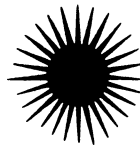

BIOTYPES

William Wolensky

Medical and behavioral sciences have concluded that there are specific personality types or 'Biotypes' that can be identified as having a unique predisposition for specific diseases. This awareness suggests that more emphasis can be psychotronically directed toward the identification and alleviation of the identifiable disease predisposers.

PSYCHOTRONIC RESEARCH AND INSTRUMENT DESIGN

Kathleen Joyce

This paper discusses some intriguing areas for psychotronic research and some ideas for specialized psychotronic instruments with which to research these areas. It deals with the time properties of the psychotronic instrument and its use as a predictive instrument. It describes a psychotronic instrument device which would allow for an infinite number of rates. The question as to whether psychotronic rates are relative or absolute is also considered. The possible use of

radionic instrumentation for quality control, chess playing, archeology, astronomy, high-energy particle physics and the administration of justice is also considered. It is suggested that rather than trying to *first* get psychotronics adopted in the health field, that we demonstrate its indispensability to other areas of research. Then, like the computer, it will be universally acknowledged as a very valuable tool, and the health industry will also want to avail itself of its benefits.

THE MATHEMATICS OF CONE DESIGN

Joseph W. Maguire

The paper presents a set of formulas for designing and constructing cones. A wide range of technical information is provided by the formulas. This range of data includes such areas as the physical characteristics of a cone, the quantities of materials needed to construct a cone, various measurements used in construction of

a cone and data needed to use cones in pyramid power experiments. The formulas were developed from data published by G. Patrick Flanagan, Ph.D. (1).

1. G. Patrick Flanagan, Ph.D. *Beyond Pyramid Power*, (Devorss & Co., Santa Monica, Ca, 1975), p. 44, pp. 58-61.

Perception Physics

J. G. Gallimore

(Part I—9 pages)

This paper starts with Einstein physics of space/time stresses, and proceeds backwards so that time density fields are revealed wherever any mass stressed is acting.

(Part II—14 pages)

The foundation physics for bio-physical existence as well as actual perception as a mind quantity are expressed in the new stress model. The 'mind' quality as well as quantity are for the first time directly expressible in mathematical models with a corres-

ponding means of evaluation, monitoring, and changing of the same by artificial means.

The expansion or contraction of "mind" is found to be directly proportional to the space/time stresses incurred by the bio-body.

This preliminary physics excursion into new areas predicts that future medical or metaphysical areas are both potentially able to utilize space/time stresses as tools—perhaps the ultimate controlling tools.

1980 CONFERENCE

continued from page 4



The Directors chose the following executive group from among their own numbers:

J. G. Gallimore—*President*
Peter Kelly — *1st Vice President*
David Rhoads — *Executive Secretary*
Robert Beutlich — *Secy-Treasurer*

In substance and in atmosphere, the 1980 USPA Conference was judged by participants as a success. Supportive comments praised advance planning by the Conference Committee chaired by Peter Kelly and the Executive Council headed by outgoing President David Rhoads. The choice of the quiet suburban center and Bergamo Hall met with such general approval that the Executive Council accepted without discussion Conference Chairman Kelly's invitation for a return to Dayton in 1981.

Although complete figures were not yet available at the time of this report, Secretary-Treasurer Robert Beutlich estimates the 1980 meeting to be and unqualified financial success.

A proceedings of the conference is now in process of being organized and is expected to be ready for distribution by the year's end.

Details of the 1981 conference as well as other information generated as the 1980 meeting will be reported in the winter issue of the newsletter, to appear in November.

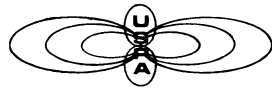
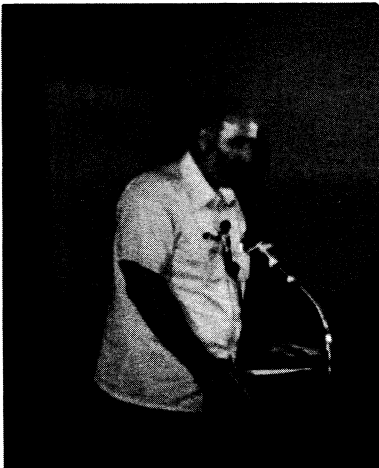

Upper left: Outgoing President David Rhoads opens the conference.

Middle left: Kathleen Joyce Baumgartner presents her paper.

Bottom left: Thomas E. Bearden, Lt. Col. US Army (Ret) addressing the assemblage.



Ivan Kruglak , on left, demonstrating the Mind-Mirror with the assistance of Ann Johnson, on right, and a volunteer in the center. The use of two instruments as illustrated here, permits the visual observation of the states of consciousness of the two sensitives for comparison.

THE 1981 USPA CONFERENCE

returns to

**Bergamo Hall
Dayton, Ohio**

**WATCH THE NEXT ISSUE
OF USPA'S NEWSLETTER
FOR DATES AND DETAILS**



1980 USPA

Rev. Henry J. Nagorka, Awards Committee Chairman, presents the 1980 USPA Achievement Award to John Moray, son of award winner T. Henry Moray.

The reporting s





At the award banquet, facing the speakers' table. Left to right: Dr. Charles Whitehouse, Thomas Bearden, Ann Johnson, Robert Beutlich (standing), John Moray, David Rhoads, Peter Kelly, Kathleen Joyce Baumbartner, Paul Sauvin and J. G. Gallimore.

CONFERENCE

Clinton Miller, National Health Federation President, accepts USPA's 1979 posthumous Achievement Award for Dr. Albert Abrams from David Rhoads. As keynote speaker, Dr. Miller gave powerful support to the Charles Whitehouse defense effort.

essions were well attended.



Magnetic Pacer

Environmental electromagnetic pollution countermeasure © 2/11/80 Bill Bise

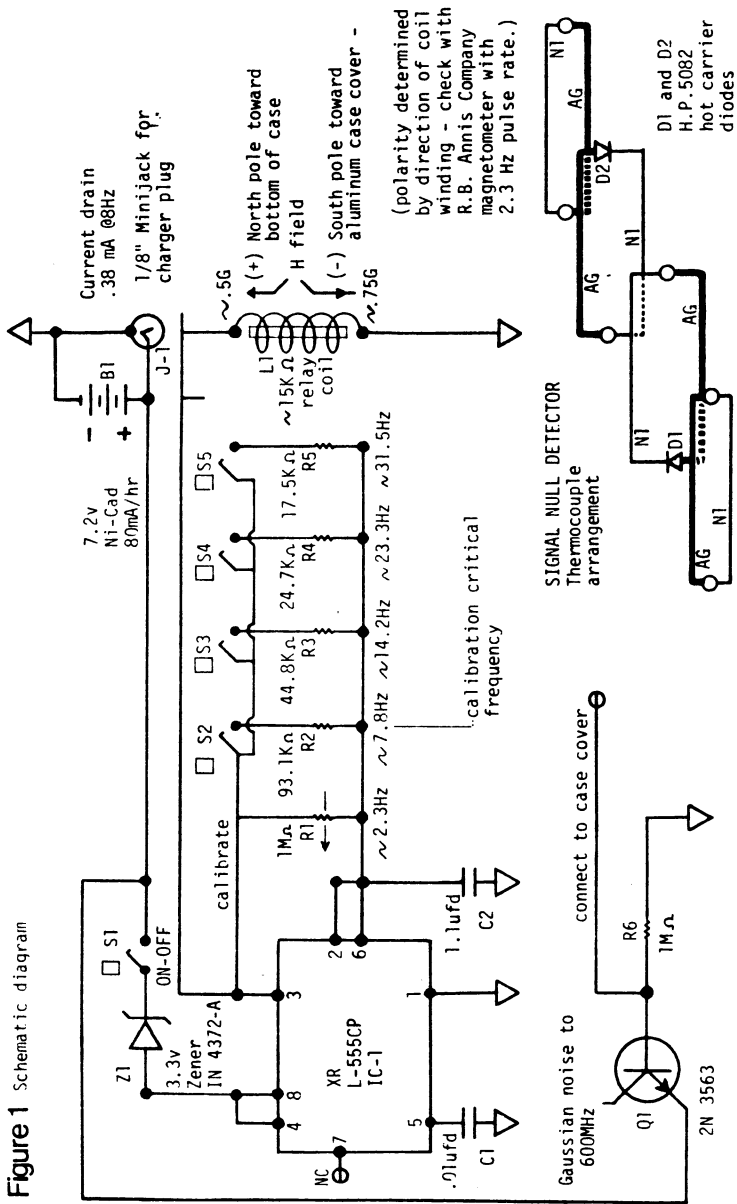

THE MAGNETIC PACER— A COUNTERMEASURE FOR EXTREMELY LOW FREQUENCY MAGNETIC RADIATION

William Bise

The environment of the planet has become increasingly filled with man-made electromagnetic waves in the last decades. Most of the signals and power levels of the waves serve useful and vitally beneficial purposes for mankind and other living systems. Unfortunately, there also has been an increase in the power levels and numbers of signals which produce significant interference to the lawful communications and navigational systems and the electronic products upon which our civilization has become so dependent. Many of the electronic products, such as computers and medical instrumentation systems, are extremely sensitive devices; yet, compared to the delicate complex electrical and chemical signals in human and animal brain and cardiac systems, these electronic products are relatively unresponsive. Electronic components of the central nervous system govern many behavioristic patterns in living systems.

THE ELF POLLUTION'S BIOLOGICAL EFFECT

The combination of high intensity ELF (Extreme Low Frequency) magnetic signals from both the U.S. and the U.S.S.R. may be significant enough to produce effects on humans as well as other living systems. *Such effects, when they exist, would not normally be perceived by the individuals affected because the electrical activity of the central nervous system would be altered.* Since human perception is a direct result of the chemical and electrical activity of the brain, one would

not normally be able to determine whether perception has been altered. Special biological instrumentation systems can detect alterations of biological electrical activities, however, and thus provide a means by which one may monitor alterations in behavior patterns not otherwise observable. A simultaneous comparison of biological signals with external magnetic and electric signals in the environment has shown that *human electroencephalograms will occasionally lock onto some of these external signals, or otherwise show external modifications.*

Robert Beck with **Andrija Puharich** noted such correlations in the ELF range in 1977. I found similar patterns in a research study with micro wave frequencies in 1975 and verified the finding in the ELF range in 1978-1979.

Considerations of the implications of this information led to the development of the magnetic pacer which is currently under test. Some earlier scientific studies have been conducted, notably by **H.W. Ludwig** of the Federal Republic of Germany, into the feasibility of developing devices pulsed within the ELF range which reportedly were beneficial for some people (especially that country's diplomatic community), and sold under the trade name, "**Vitasette**".

The purpose of the pacer unit is to *reintroduce a natural field into a localized area of about 1 meter radius.* A 7.8 Hz frequency lies near the base of the range of natural frequencies known as the Schuman earth-ionosphere resonances. This 7.8 Hz frequency has appeared to be able to pace the human

Figure 2
Parts Layout

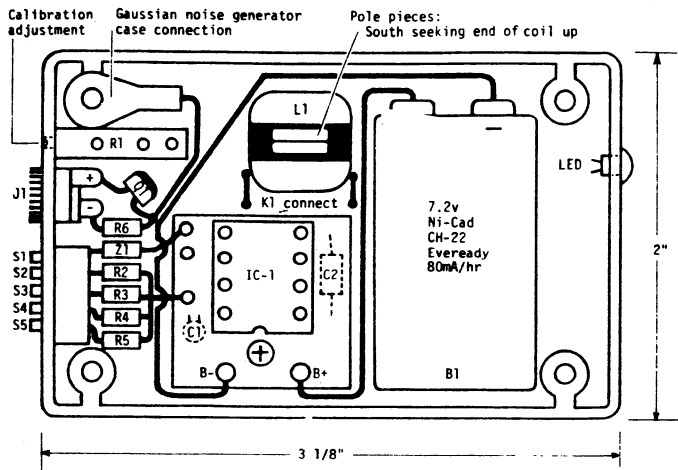
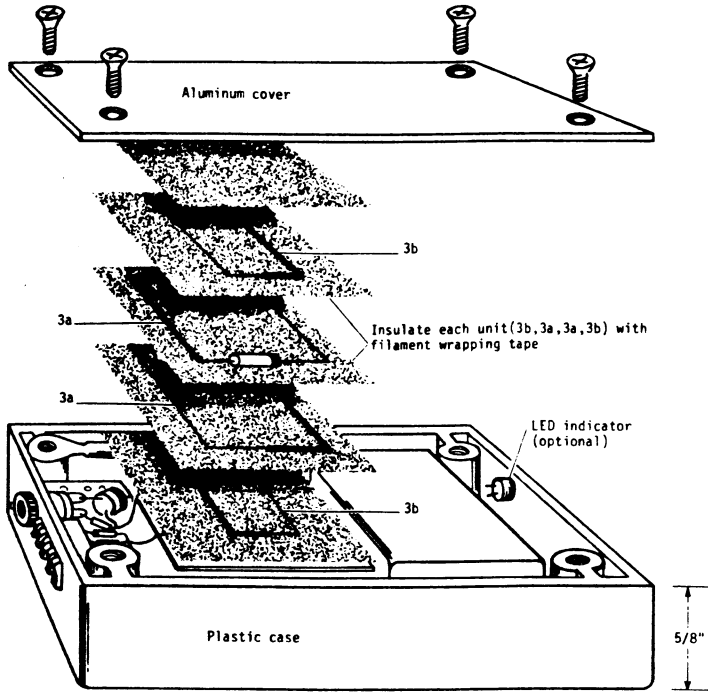

heartbeat and affect the brain wave patterns of some people; it may be useful for inducing relaxed or sleep states. The higher frequencies may be useful in enhancing alert states in some persons. A pulsed south polar field has been seen to more easily affect males while a north polar field has been seen to more easily affect females. Placing a pacer next to the left chest, pulsing at 7.8 Hz, has shown that the heart will rhythmically respond in some persons when at rest, sitting quietly.

Studies have shown that specific low level electric and magnetic fields and frequencies have profound effects on almost all biological systems on this planet. Therefore, it seems reasonable to assume that alterations of natural fields may produce alterations in biological system response; *thus a method of reintroducing approximate natural field conditions may be able to produce what was once natural biological system response.*

It should be clearly understood that this magnetic pacer is an experimental unit and that no claims whatsoever are made regarding specific effects which may, or may not, occur to individual experimenters. The small group of persons who volunteered to participate, out of curiosity, as test subjects, is too small a sample of the population to know with any certainty what the specific effects of such a device may turn out to be on the overall human population.

A special text which includes the parts list, notes and construction details for the Magnetic Pacer is available from the USPA for the cost of \$5.00.

(Reprinted from the July/August 1980 **Planetary Association for Clean Energy** newsletter, 100 Bronson/1001, Ottawa K1R 6G8, Canada (613) 236-6265.

Figure 3
Signal Null Detector
(thermocouple construction)

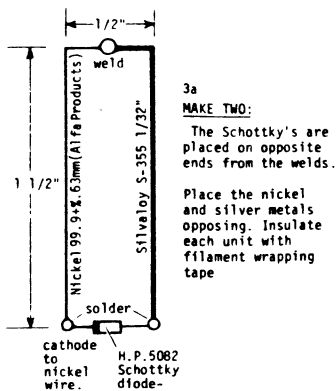

NOTE:
Weld with butane blow torch.
Use ULTRA FLUX with wire. Heat wire carefully, dip in flux, then touch both metals together and hold briefly in point of flame until joined—the metals will fuse rather quickly, so use caution.

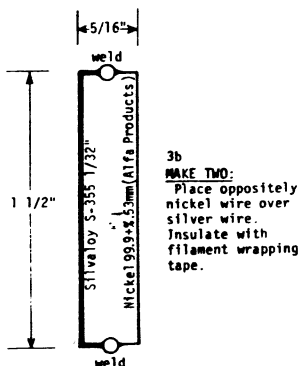

UNITED STATES PSYCHOTRONICS ASSOCIATION INC.

1. To promote the free exchange, discussion and dissemination of information, theories, ideas and practices related to psychotronics.
2. To maintain high standards of ethics, humanitarianism and scientific practices in the study and application of psychotronics.
3. To preserve the history and geneology of psychotronics.
5. To secure cooperative action in advancing the common cause of its members.
6. To disseminate information of a general, economic, social or governmental character, to analyze subjects relating thereto, and to secure and present the views of its members to other organizations, the government, and the public.
7. To cooperate with other organizations of like interests.
8. To further the training and education of its members.
9. To promote standardization in the investigation, testing, reporting and evaluation of psychotronics.
10. To provide in its periodical(s) a national forum for the report and publication of all worthy activities and projects of persons, groups or organizations working in the field of psychotronics.
11. To make awards, locally and nationally, to persons, associations or agencies, in recognition of outstanding contributions or accomplishments in the field of psychotronics.

MEMBERSHIP

The U.S. Psychotronics Association, incorporated in the District of Columbia in August 1977, is empowered to enroll members in the parent organization and to develop chapters throughout the nation.

There is little doubt that social, scientific and industrial developments in the United States and abroad are moving in the directions espoused in the study of Psychotronics.

Five categories of membership are open to the imaginative individual who wishes to join with the U.S.P.A. on the new frontiers of science in working constructively for the qualitative improvement of man and his environment.

1. *General*—\$20.00 per year (any citizen of the United States).
2. *Affiliate*—\$13.00 per year (any firm, corporation, or organization).
Non-voting.
3. *Student*—\$10.00 per year (any full-time student attending an accredited educational institution; or member of the armed forces of the United States).
4. *Fellow*—\$40.00 per year (any U.S. citizen active in Psychotronics, deemed eligible by the Board of Directors).
5. *Honorary*—No fee (granted for life by the Board of Directors for outstanding service).

NEW AND RECENT BOOKS
ON PSYCHOTRONICS
and Related Subjects

THE CYCLES OF HEAVEN, COSMIC FORCES AND WHAT THEY ARE DOING TO YOU, by Guy L. Playfair and Scott Hill, 1978. Avon Books, The Hearst Corporation, NY, paperback, 364 pp., \$2.75

"*The Cycles of Heaven*" is an attempt to present a coherent picture of man in his cosmic environment; to understand the interactions of man and nature, including those of which he is not consciously aware. For some form of invisible force affects everything on, above and under the Earth, whether living or dead.

The Cycles of Heaven is a collaboration between a research scientist (Playfair) trained in biophysics, an interdisciplinary science, and a writer (Hill) interested in the unexplained border areas of human activity. They are repeating an old question posed by T. S. Eliot, "Where is the knowledge we have lost in information?" referring to the vast amount of scientific data that has accumulated in the Space Age. This knowledge of our environment is increasing daily, but what does it tell us of "inner space" which is as exciting as outer space and of more immediate importance?

In the beginning the reader is compelled to look at the Earth as a planet in its cosmic environment centered on its local star, the Sun. Other planets are explored in terms of their relationships, via astronomy and astrology. The two principle invisible forces, gravity and electromagnetism, are introduced as background to man's interactions with nature. Earthquakes are shown as examples of natural and strange forces in their most extreme and destructive actions (with great visible effects). All of this leads up to the important subject of cycles — in nature, in human affairs and in the natural rhythms of the human body and the way these cycles interact. To alert, rather than alarm the public, the authors show that the invisible forces in

nature can and do influence man's thoughts and actions. They describe means whereby he can fight back and reassert control over himself and part of his environment. From this the reader is led to venture beyond the frontiers of established science to the fascinating new concepts of man's "energy body" and its radiations. The critical climax is man's energy body interacting with its energetic surroundings for his good or his harm.

All arguments used in the discussions are rigorously based on international scientific data. But from this data come many perplexing questions.

The material varies from highly technical to a narrative essay, making it a bit difficult to follow. The vast number of references given became at times confusing. There is almost too much information used to prove an argument. But if one only wanted to pick and choose, there is still much to be garnered from this treatise on Cycles.

The authors more than achieved their purpose of showing how man interacts with his environment, whether inside his skin or out in the cosmos. They gave fresh insights into man's responsibilities for cooperation and consideration of nature and its varied operations.

For the uninitiated this book may be rough going. One has to understand the scientific data and logic before applying the discoveries.

For the metaphysician it is indeed appropriate and should prove both provocative and stimulating. Reading the chapters on "Homo Electromagneticus," "Bio-Entrainment," "Bio-Feedback/Self-Entrainment," "The Electro-Magnetic Web," and "The Energy Body" (which is not new to occultists), will bring the uninformed up to date in short order, while with the same effort, it affords some hearty "food for thought."

Eugenia Nowlin

**Long Awaited
"Excalibur Briefing"
Makes Debut**

The challenging and revolutionary concepts which have been the focus of Lt. Col. Thomas Bearden's (U.S. Army Ret'd.) studies and researches in the field of psychotronics for more than a decade have made their appearance as *The Excalibur Briefing*.

Published by Walnut Hill of San Francisco, California, after numerous misadventures, the 288 page illustrated soft back has been eagerly awaited by researchers and metaphysicians alike. The book carries a foreword by John White and is illustrated by Hal Crawford.

Although slightly marred by compositional shortcomings and such details as missing or unclear cross references to illustrations and diagrams, the book offers the first complete collection of Bearden's innovative thinking. Unquestionably, his "Fourth Law of Logic," "The Kindling Effect," and view of space-time-light relationships, are "a time bomb ticking away at the heart of physics."

In the opinion of this reviewer Bearden's book indicates that he is emerging as one of today's most profound and erudite "metascientific" philosophers.

Do not, for any reason whatsoever fail to read and study the "*Excalibur Briefing*."

—Rev. Henry J. Nagorka

Colonel Thomas E. Bearden, a research scientist in the fields of military intelligence and nuclear weapons for over 23 years, has written a definitive book that vastly expands our understanding of paranormal phenomena.

THE EXCALIBUR BRIEFING

With the incisive power of the Excalibur sword of legend, this book cuts through the morass of confusing paranormal happenings and provides highly credible and technically sound explanations. *The Excalibur Briefing* is written for the entire range of paranormal "enthusiasts" — from amateur to the most expert.

Part One discusses specific paranormal phenomena, such as UFO's, mystery lights, free energy devices, crystal skulls, thought photography, spacemen, cattle mutilations, psychic surgery, and ghost rockets. All of these phenomena are then explained by the fascinating theories presented in Part Two. Part Three contains a wider message, of immense significance to us all. Colonel Bearden clearly demonstrates the dangers inherent in Soviet psychotronic mind control research. What may well become classified data is here revealed with a strong sense of urgency—the West must wake up to this danger before it is too late.

The author of numerous technical publications, Colonel Bearden is widely respected in the field of paranormal studies both as a teacher and as a writer.

**NOW AVAILABLE
FROM USPA**

Price:	Book	\$8.95
	U.S. postage & handling	1.00
	Total	\$9.95

This is a Quality Paperback Book, 288 pp., 6 by 9 inches, extensively illustrated with photographs and diagrams. ISBN 0-89407-015-0. A Walnut Hill Book.

**TAPES OF PAPERS
PRESENTED AT 1978
USPA CONFERENCE, ATLANTA, GEORGIA**

1. **Radionics, Vortices and the Future.** Kathleen Joyce and Walter Baumgartner.
2. **Energy Field Detection and Analysis Through Muscle Testing.** Neil F. Michelsen.
3. **Etheric Energies as Related by Edgar Cayce.** Charles Whitehouse.
4. **Sensing the Energy of Form.** Bill Cox.
5. **Parallel Universes.** Dr. Paul Louis Laussac
6. **Time/Space—The Eternal Presence.** Dr. Paul Louis Laussac.
7. **Psychotronics and Mind.** Ann Johnson.
8. **Soviet Psychotronic Weaponry.** Thomas E. Bearden.
9. **From the "Black Box" to the Radiation Lab—The Evolving Psychotronic Instrumentation.** T. Galen Hieronymus.
10. **The Evolving Animal Man and UFO's.** Henry Montieth.
11. **Extremely Low Frequency Magnetic Fields and EEG Entrainment. A Psychotronic Warfare Possibility?** Robert C. Beck.
12. **Application of Color Therapy and Psychotronics to Possession.** Charles Whitehouse.
13. **Methods of Detecting and Measuring Healing Energies.** Robert N. Miller and Paul Sauvin.
14. **[a] The Ring That Sings. [b] Quarks, Occult Chemistry and Velocity of Energy Beyond the Physical.** Robert Beutlich.

Order from:

U.S. Psychotronics Association, Inc.
3459 Montrose Ave.
Chicago, IL 60618

TAPE ORDER

Name _____

Address _____

City _____ State _____ Zip _____

PLEASE SEND ME TAPES NUMBERS (CIRCLE)

1 2 3 4 5 6 7 10 12 13 14 a \$5.00 _____

8, 9, and 11 (Doubles) a \$8.00 _____

Postage \$1.50 _____

Full Set 17 Tapes \$65.00 _____

Overseas Shipping \$5.00 _____

Note: All Overseas Payments by Dollar Drafts on American Banks.

**TAPES OF 1979 USPA CONFERENCE
UNIVERSITY OF HOUSTON, TEXAS**

- | | |
|--|---|
| <p>C-1 Parapsychology and Physics, 40 min., J.G. Gallimore</p> <p>C-2 Psychotronic Technology, State of the Art, 40 min., Earle Lane</p> <p>C-3 Survey of Physics, Year 2001, 90 min., Robert Beutlich</p> <p>(C-4) History of Radionics Part 1, 90 min., T.G. Hieronymus</p> <p>(C-5) History of Radionics Part 2, 90 min., T.G. Hieronymus</p> <p>C-6 Color, Vibrations, Radionics ELF to Light, 90 min., Peter Kelly</p> <p>C-7 Dinner Speaker: Awards Presentations 90 min., Rose Gladden</p> <p>(C-8) Possession - Panelists Henry Nagorka, Ruth Gladden, Charles Whitehouse, Ann Johnson, Marie Rhodes, 90 min., Possession" Panel</p> <p>(C-9) Part 2 (continuation of above), 22 min., Possession" Panel</p> <p>C-10 Ancient Egyptian Technology, 90 min., Bill Cox</p> <p>C-11 New Instrumentation for Radionics, 90 min., Charles Whitehouse</p> <p>C-12 History of Dowsing, 90 min., Chris Bird</p> | <p>C-12A Pilot Study of the Effect of Gravity Phasor Emitter on Growth of Staph & Coll Colonies, 30 min., Gallimore paper (Charlene Small, read by David Rhodes)</p> <p>C-13 Extreme Low Frequency Magnetic Pulses and E.E.G. Entrainment Soviet Psychotronic Weapon? 90 min. Bob Beck</p> <p>(C-14) Soviet Psychotronic Weapons Part 1, 90 min., Thomas Bearden</p> <p>(C-15) Soviet Psychotronic Weapons Part 2, 20 min., Thomas Bearden</p> <p>C-16 Ask the Experts, Panelists Beck, Bearden, Hieronymus, Gallimore, Nagorka 90 min., Panel</p> <p>(C-17) The Mind Mirror (with Ruth Harvey) Part 1, 90 min., Rose Gladden</p> <p>(C-18) The Mind Mirror Part 2, 90 min., Rose Gladden</p> <p>C-19 Detection of Human Interactions Over a Distance, 90 min., Paul Sauvin</p> <p>C-20 Human Frequency Research, 90 min., Joan Orion</p> <p>C-21 Biospheric Applications, 45 min., Jason Janus</p> |
|--|---|

Entire program of 22 tapes = \$80.00 plus postage (20 percent savings)

ORDER FROM:
U.S. Psychotronic Association, Inc.
3459 Montrose Avenue
Chicago, IL 60618

TAPE ORDER									
Name _____									
Address _____									
City _____			State _____				Zip _____		
PLEASE SEND ME TAPES NUMBERS (CIRCLE)									
C-1	C-3	C-7	C-11	C-12A	C-16	C-20	a \$5.00 _____		
C-2	C-6	C-10	C-12	C-13	C-19	C-21			
C-4-5		C-8-9	C-14-15		C-17-18 (Doubles)		a \$8.00 _____		
							Postage		\$1.50 _____
							Overseas Shipping		\$5.00 _____
Note: All Overseas Payments by Dollar Drafts on American Banks.									

TAPES OF PAPERS
PRESENTED AT 1980
USPA CONFERENCE, DAYTON, OHIO

- D-1 Training in Energy Awareness, Joan Orion
- D-2 Quarks, Occult Chemistry and the String Model, Robert Beutlich
- D-3 Radionic Instruments, Research and Design, Kathleen Joyce Baumgartner; Mathematics of Cone Design, Joseph Maguire
- D-5 Virginia Board of Medicine versus Whitehouse, Dr. Charles Whitehouse,
- D-5 National Health Federation of the Whitehouse Case, Clinton Miller, Dir. N.H.F.
- D-6 Bio-Types, William Wolensky
- D-7 A Magnetic Pacer, Al Bielek and William Bise,
- D-8 Commentary on the Hieronymus Videotape Lecture, Peter Kelly; Open Discussion - Radionics, Sam Lentine, Jack Minkowitz, William Strandwitz, Dr. Julius Soled and David Rhoads
- D-9 Mind and Matter Interaction, Thomas Bearden (2 tapes)
- D-10 Mind-Mirror Demonstration, Ivan Kruglak
- D-11 Paraphysics Exploration - A Set of Axioms, J.G. Gallimore
- D-12 Sea of Energy, John Moray (Key-noter)
- D-13 Alteration of Brain Frequencies for Space Communication, Ann Johnson

Complete Sets (\$70.00) are discounted 20% = \$56.00

ORDER FROM:
U.S. Psychotronic Association, Inc.
3459 Montrose Avenue
Chicago, IL 60618

TAPE ORDER												
Name _____												
Address _____												
City _____				State _____				Zip _____				
PLEASE SEND ME TAPES NUMBERS (CIRCLE)												
D-1	D-2	D-4	D-5	D-6	D-7	D-10	D-11	D-12	D-13	at \$5.00	_____	
Note: All Overseas Payments by Dollar Drafts								D-3	D-8	at \$6.00	_____	
on American Banks.										D-9	at \$8.00	_____
										Domestic Postage = \$1.50	_____	
										Overseas Mailing = \$5.00	_____	

U.S. PSYCHOTRONICS ASSOCIATION, INC.

3459 Montrose Avenue
Chicago, Illinois 60618

Address Correction Requested